

## **WARNING**

The rudder pedals are suspended from a torque tube which extends across the fuselage. The pilot should become familiar with the proper positioning of his feet on the rudder pedals so as to avoid interference with the torque tube when moving the rudder pedals or operating the toe brakes.

757 436

# **CHEROKEE 140**

**PA-28-140**

## **Owner's Handbook**



**Piper Aircraft Corporation, Vero Beach, Florida  
U. S. A.**

## NOTICE

THIS HANDBOOK IS NOT DESIGNED, NOR CAN ANY HANDBOOK SERVE, AS A SUBSTITUTE FOR ADEQUATE AND COMPETENT FLIGHT INSTRUCTION, OR KNOWLEDGE OF THE CURRENT AIRWORTHINESS DIRECTIVES, THE APPLICABLE FEDERAL AIR REGULATIONS, AND ADVISORY CIRCULARS. IT IS NOT INTENDED TO BE A GUIDE OF BASIC FLIGHT INSTRUCTION, NOR A TRAINING MANUAL.

THE HANDBOOK IS DESIGNED:

1. TO HELP YOU OPERATE YOUR CHEROKEE WITH SAFETY AND CONFIDENCE.
2. TO MORE FULLY ACQUAINT YOU WITH THE BASIC PERFORMANCE AND HANDLING CHARACTERISTICS OF THE AIRPLANE.
3. TO MORE FULLY EXPLAIN YOUR CHEROKEE'S OPERATION THAN IS PERMISSIBLE TO SET FORTH IN THE AIRPLANE FLIGHT MANUAL.

IF THERE IS ANY INCONSISTENCY BETWEEN THIS HANDBOOK AND THE AIRPLANE FLIGHT MANUAL APPROVED BY THE F.A.A., THE AIRPLANE FLIGHT MANUAL SHALL GOVERN.

---

Revised text and illustrations shall be indicated by a black vertical line in the margin opposite the change. A line opposite the page number will indicate that material was relocated.

Additional copies of this manual, Piper No. 753 584, may be obtained from your Piper Dealer.

---

Published by  
PUBLICATIONS DEPARTMENT  
Piper Aircraft Corporation  
753 584

Issued: February 1964  
Revised: May 27, 1977

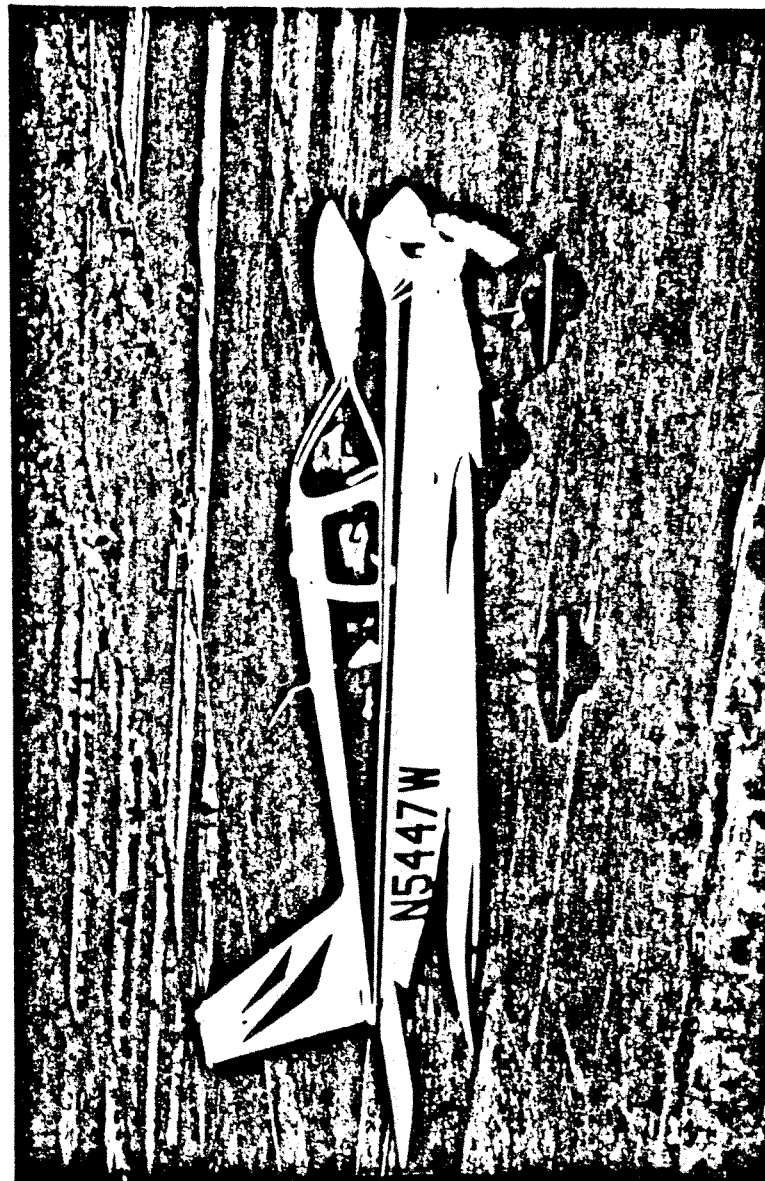

## INDEX

	Page
<b>SECTION I</b>	
Specification Features: . . . . .	1
Performance . . . . .	1
Weights . . . . .	2
Power Plant . . . . .	2
Fuel and Oil . . . . .	3
Baggage . . . . .	3
Dimensions . . . . .	3
Landing Gear . . . . .	3
<b>SECTION II</b>	
Design Information: . . . . .	5
Engine and Propeller . . . . .	5
Structures . . . . .	6
Landing Gear . . . . .	6
Control System . . . . .	7
Fuel System . . . . .	8
Electrical System . . . . .	9
Heating and Ventilating System . . . . .	10
Cabin Features . . . . .	12
<b>SECTION III</b>	
Operating Instructions: . . . . .	13
Preflight . . . . .	13
Starting . . . . .	14
Warm-up . . . . .	15
Ground Check . . . . .	16
Take-off . . . . .	16
Climb . . . . .	17
Stalls . . . . .	18
Cruising . . . . .	18
Maneuvers . . . . .	19
Approach and Landing . . . . .	19
Mooring . . . . .	19a
Weight and Balance . . . . .	19a

INDEX (cont.)

SECTION IV	Page
Performance Charts . . . . .	20
Take-off Distance vs Density Altitude . . . . .	20
Rate of Climb vs Density Altitude . . . . .	21
True Airspeed vs Density Altitude (1950 lbs. gross weight) . . . . .	22
True Airspeed vs Density Altitude (2150 lbs. gross weight) . . . . .	23
Range vs Density Altitude (1950 lbs. gross wt) . . . . .	23a
Range vs Density Altitude (2150 lbs. gross wt) . . . . .	23b
Power vs Altitude (1950 lbs. gross weight) . . . . .	24
Power vs Altitude (2150 lbs. gross weight) . . . . .	25
Landing Distance vs Density Altitude . . . . .	25a
Glide Distance vs Altitude . . . . .	25b
Altitude Conversion Chart . . . . .	26

SECTION V	
General Maintenance . . . . .	27
Tire Inflation . . . . .	27
Battery Service . . . . .	27
Brake Service . . . . .	27
Landing Gear Service . . . . .	28
Fuel Requirements . . . . .	30
Oil Requirements . . . . .	31
Care of Air Filter . . . . .	32
Care of Windshield and Windows . . . . .	32
Serial Number Plate . . . . .	33
Leveling and Rigging . . . . .	33

**SECTION I**

**SPECIFICATION FEATURES**

Performance . . . . . 1  
Weights . . . . . 2  
Power Plant. . . . . 2  
Fuel and Oil . . . . . 3  
Baggage . . . . . 3  
Dimensions. . . . . 3  
Landing Gear . . . . . 3

## SECTION I

### SPECIFICATION FEATURES

#### PERFORMANCE

The gross weight of 1950 pounds in the following performance charts applies to Serial Nos. 28-20000 to 28-20939, unless the airplane has been modified to 2150 pounds gross weight. All airplanes from Serial Nos. 28-20940 and up have been licensed from the factory at 2150 pounds gross weight.

Performance figures are for standard airplanes flown at gross weight under standard conditions at sea level, or stated altitude. Any deviation from Standard equipment may result in changes in performance.

	GROSS WEIGHTS	
	<u>1950</u>	<u>2150</u>
Take-off Run (ft.) (flaps up)	725	800
Take-off Distance Over 50 ft. Obstacle (ft.) (flaps up)	1500	1700
Best Rate of Climb Speed (mph)	85	85
Rate of Climb (ft. per min.)	820	660
Service Ceiling (ft.)	15,000	14,300
Absolute Ceiling	17,000	16,800
Top Speed (mph)	141 (144*)	139 (142*)
Cruising Speed (75% power, sea level) (mph)	120 (123*)	121 (124*)
Optimum Cruising Speed (75% power, 7000 ft., mph)	130 (133*)	130 (133*)
Instructional Power Cruise Speed (50% power, sea level)	100 (102*)	100 (102*)
Fuel Consumption (gal. per hr. 75%)	7.9	8.4
Fuel Consumption (gal. per hr. 50%)	5.3	5.6
Cruising Range (75% power, sea level, mi.)	515, 4 hrs. (720, 6 hrs.**)	490, 4 hrs. (680, 6 hrs.**)
Cruising Range (75% power, 7000 ft., mi.)	560 (780**)	535 (725**)
Optimum Cruising Range (55% power, 10,000 ft.)	600 (840**)	570 (790**)

\*When Fenders Installed

\*\*With 50 gal. Reserve Fuel

## SPECIFICATION FEATURES: (cont)

## PERFORMANCE

	GROSS WEIGHTS	
	1950	2150
Instructional Power Cruising Range (50% power, sea level)	640, 6.5 hrs. (895, 9 hrs.**)	650, 6.5 hrs. (910, 9 hrs.**)
Stalling Speed (flaps down, mph)	52	54
Landing Roll (flaps down, ft.)	485	535

## WEIGHTS

	1950	2150
Gross Weight (lbs.)	1950	2150
Empty Weight (Standard) (lbs.)	1180	1201
USEFUL LOAD (Standard) (lbs.)	770	949
Empty Weight (AutoFlight) (lbs.)	1220	1241
USEFUL LOAD (AutoFlight) (lbs.)	730	909

## POWER PLANT

	O-320-E2A	O-320-E2A
Engine - Lycoming	O-320-E2A	O-320-E2A
Rated Horsepower and Speed (rpm)	140 at 2450	150 at 2700
Bore (inches)	5.125	5.125
Stroke (inches)	3.875	3.875
Displacement (cubic inches)	319.8	319.8
Compression Ratio	7:1	7:1
Dry Weight (pounds)	272	272
Oil Sump Capacity (qts.)	8	8
Propeller (Sensenich)	M74DM	M74DM

\*With 50 gal. Reserve Fuel

## SPECIFICATION FEATURES: (cont)

	GROSS WEIGHTS	
	1950	2150
<b>FUEL AND OIL</b>		
Fuel Capacity (gal.) Standard	36	36
Fuel Capacity (gal.) Reserve	50	50
Oil Capacity (qts.)	8	8
Fuel Aviation Grade (Minimum Octane)	80/87	80/87
(Specified Octane)	80/87	80/87
(Alternate Fuels)	See page 30	

## BAGGAGE

	1950	2150
Maximum Baggage (lbs.)	100	200***
Baggage Space (cubic ft.)	22	22

## DIMENSIONS

	1950	2150
Wing Span (ft.)	30	30
Wing Area (sq. ft.)	160	160
Wing Loading (lbs. per sq. ft.)	12.2	13.4
Length (ft.)	23.3	23.3
Height (ft.)	7.3	7.3
Power Loading (lbs. per HP)	13.9	14.3

## LANDING GEAR

	1950	2150
Wheel Base (ft.)	6.2	6.2
Wheel Tread (ft.)	10.0	10.0
Tire Pressure (lbs.)		
Nose	24	24
Main	24	24

\*\*\*Except when family seat and safety belts are installed, 340 lbs. is permitted.

65063

770527

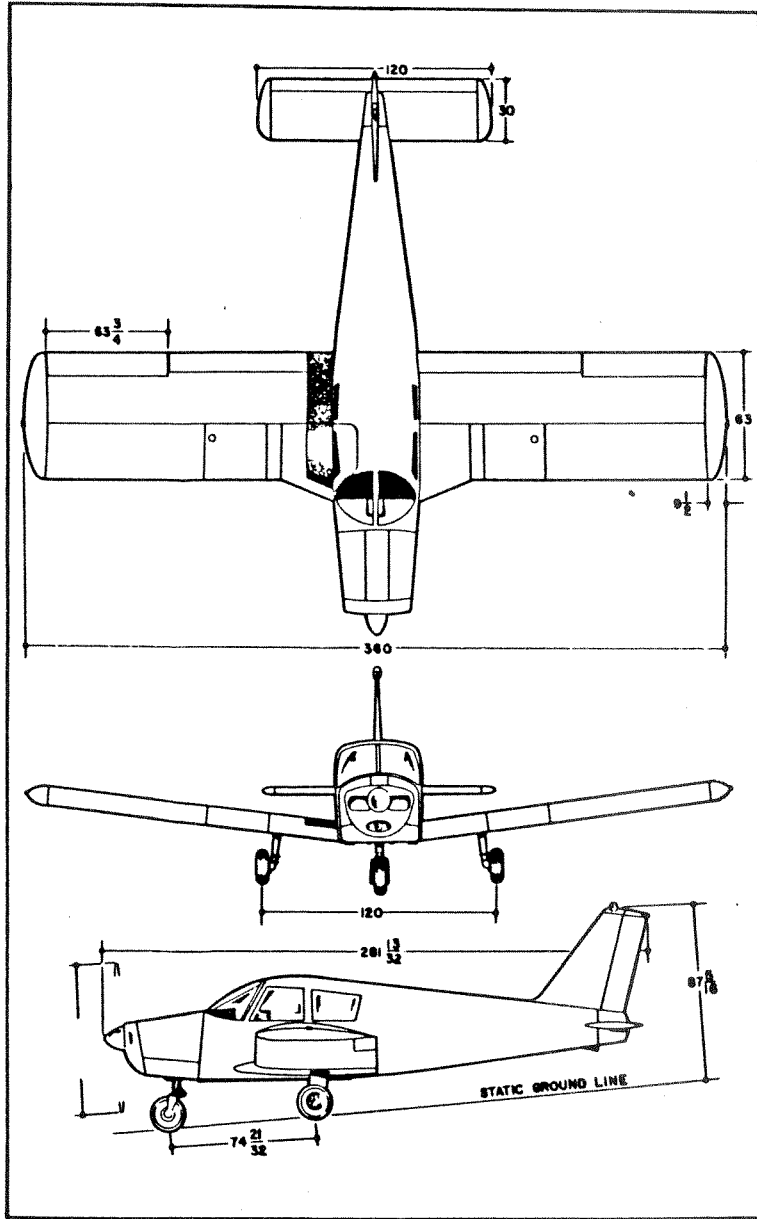

SECTION II

DESIGN INFORMATION

Engine and Propeller . . . . .	5
Structures . . . . .	6
Landing Gear . . . . .	6
Control System . . . . .	7
Fuel System . . . . .	8
Electrical System . . . . .	9
Heating and Ventilating System . . . . .	10
Cabin Features . . . . .	12



## SECTION II

### DESIGN INFORMATION

#### ENGINE AND PROPELLER

The Lycoming O-320-E2A engine installed in the Cherokee PA-28-140 is rated at 140 horsepower at 2450 rpm or 150 horsepower at 2700 rpm\*\*. This engine has a compression ratio of 7 to 1 and requires 80/87 minimum octane fuel. Refer to Fuel Requirements on page 30 when using alternate fuels. The engine is equipped with a geared starter, a 35 ampere alternator, dual magnetos, vacuum pump drive, a diaphragm-type fuel pump and a float carburetor.

Exhaust gases are carried through a system constructed of heavy gauge stainless steel which incorporates a heater shroud, to provide cabin heat and carburetor deicing.

The propeller used on the PA-28-140 is a Sensenich M74DM fixed-pitch aluminum alloy unit. Its diameter is 74 inches with a standard pitch of 60\* inches. All performance figures are based on the standard 60\* inch pitch propeller.

Cowling on the Cherokee is designed to cool the engine in all normal flight conditions, including protracted climb, without the use of cowl flaps or cooling flanges.

The throttle is of the push-pull type and is located in the lower center of the instrument panel. A knurled friction lock is provided to prevent creeping of the throttle from any desired position. The mixture control, located in the lower right hand side of the instrument panel, is a push-pull control like the throttle. The full rich position is obtained when the control is full forward, while the full aft position provides an idle cut-off

\*58 inch pitch propellers when gross weight is 2150.

\*\*When gross weight is 2150

for stopping the engine. Intermediate positions are used for leaning the mixture at altitudes above sea-level. The carburetor heat control, located to the left of the throttle, provides maximum carburetor heat when pulled to its full aft position. With carburetor heat off, all engine air passes through a high-efficiency dry-type filter. Therefore, prolonged ground operation with carburetor heat "ON" should be avoided, particularly on unimproved fields as the air is not filtered.

## STRUCTURES

All structures are of aluminum alloy construction and are designed to ultimate load factors well in excess of normal requirements. All exterior surfaces are primed with etching primer and painted with acrylic enamel.

The wings are attached to each side of the fuselage by inserting the butt ends of the respective main spars into a spar box carrythrough which is an integral part of the fuselage structure, providing, in effect, a continuous main spar with splices at each side of the fuselage. There are also fore and aft attachments at the rear spar and at an auxiliary front spar.

The wing airfoil section is a laminar flow type, NACA 652-415 with the maximum thickness about 40% aft of the leading edge. This permits the main spar carrythrough structure to be located under the rear seat providing unobstructed cabin floor space ahead of the rear seat.

## LANDING GEAR

The three landing gears use a Cleveland 600 x 6 wheel, the main wheels being provided with brake drums and Cleveland single disc hydraulic brake assemblies. The nose wheel and the

main gear both use 600 x 6 four ply tires. All the tires have tubes.

The nose gear is steerable through a 30 degree arc each side of neutral by use of the rudder pedals. A spring device is incorporated in the rudder pedal torque tube assembly to aid in rudder centering and to provide rudder trim. The nose gear steering mechanism also incorporates a hydraulic shimmy dampener.

The oleo struts are of the air-oil type with normal extension being 3.25 inches for the nose gear and 4.50 inches for the main gear under normal static (empty weight of airplane plus full fuel and oil) load.

The brakes are actuated by a hand lever and master cylinder, which is located below and behind the left center of the instrument sub-panel. The brake fluid reservoir is installed on the top left front face of the firewall. The parking brake is incorporated in the master cylinder and is actuated by pulling back on the brake lever, depressing the knob attached to the left side of the handle and then releasing the brake lever. To release the parking brake, pull back on the brake lever to disengage the catch mechanism and allow the handle to swing forward.

## CONTROL SYSTEM

Dual controls are provided as standard equipment with a cable system used between the controls and the surfaces. The horizontal tail is of the all movable slab type, with an anti-servo tab which also acts as a longitudinal trim tab, actuated by a control on the cabin ceiling. The stabilator provides extra stability and controllability with less size, drag, and weight than conventional tail surfaces. The ailerons are provided with a differential action which tends to eliminate adverse yaw in turning maneuvers and also reduces the amount of coordination

required in normal turns.

The flaps are manually operated, balanced for light operating forces and spring loaded to turn to the up position. A past-center lock incorporated in the actuating linkage holds the flap when it is in the up position so that it may be used as a step on the right side. The flap will not support a step load except when in the full up position, so it must be completely retracted when used as a step. The flaps have three extended positions, 10, 25 and 40 degrees.

## FUEL SYSTEM

Fuel is stored in two twenty-five gallon tanks, which are secured to the leading edge structure of each wing by screws and nut plates. This allows easy removal for service or inspection.

The standard quantity of fuel is 36 gallons for the Cherokee 140. To obtain the standard quantity of fuel, fill the tanks to the bottom of the filler neck indicator.

An auxiliary electric fuel pump is provided for use in case of failure of the engine driven pump. The electric pump should be on for all take-offs and landings.

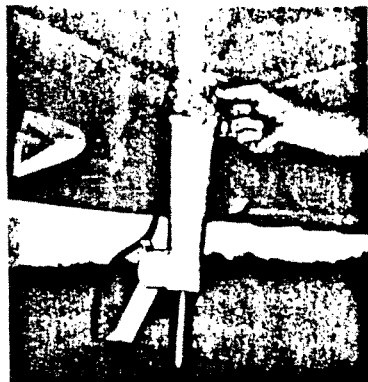

The fuel strainer, which is equipped with a quick drain, is located on the front lower left corner of the firewall. This strainer should be drained regularly to check for water or sediment accumulation. To drain the lines from the tanks,

the tank selector valve must be switched to each tank in turn, with the electric pump on, and the gascolator drain valve opened. Each tank has an individual quick drain located at the bottom, inboard, rear corner.

Fuel quantity and pressure are indicated on gauges located in the engine gauge cluster on the right side of the instrument panel.

## ELECTRICAL SYSTEM

The Cherokee is equipped with the Piper F.T.P. (Full Time Power) Electrical System. Its 12 volt alternator provides electrical power at all engine speeds and results in improved performance for radio and electrical equipment and longer battery life.

In addition to the alternator, the electrical system includes a 25 ampere-hour battery, a voltage regulator and a master switch relay. The battery and relay are mounted beneath the baggage compartment floor. Access for service or inspection is obtained by raising the hinged baggage compartment floor panel. The battery box is designed to accommodate a larger capacity battery for extreme cold weather operation.

Electrical switches, fuses and fuse spares are located on the lower left side of the instrument panel.

Standard electrical accessories, in addition to those already listed, include a starter, stall warning indicator, cigar lighter and ammeter. Navigation lights, anti-collision light, landing light, instrument lighting and a cabin dome light are offered as optional acces-

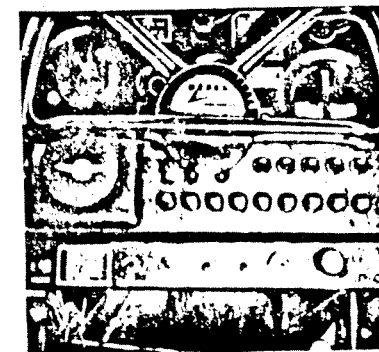

sories.

Circuit provisions are made to handle optional communications and navigational equipment.

In conventional generator systems, the ammeter indicates battery discharge. In the Piper Full Time Power electrical system, the ammeter displays the load in amperes placed on the system at any given time. With all electrical equipment except the master switch in the "OFF" position, the ammeter will indicate the amount of charging current demanded by the battery. This amount will vary and depends on the percentage of full charge on the battery at the time. When the battery becomes charged, the current displaced on the ammeter will reduce to a minimum value of about two amperes. As each unit of electrical equipment is switched on the amount of current it draws will be shown on the ammeter. The maximum continuous load for night flight with all equipment on is approximately thirty amperes. This thirty amperes plus approximately two amperes for the fully charged battery will appear continuously under these flight conditions.

Because of the mechanical simplicity of the alternator, maintenance should prove to be a minor factor as compared to previous systems. Should service be required, contact your local Piper dealer.

## HEATING AND VENTILATING SYSTEM

Heat for the cabin interior and the defroster system is provided by a heater muff attached to the exhaust system. Controls for these systems are located on the lower right hand side of the instrument panel. A third control in this area regulates a large fresh air vent located on the left hand side of the cabin near the pilot's feet. In addition, two side vents are provided, one at each seat location. They may be independently regulated as desired by the seat occupant.

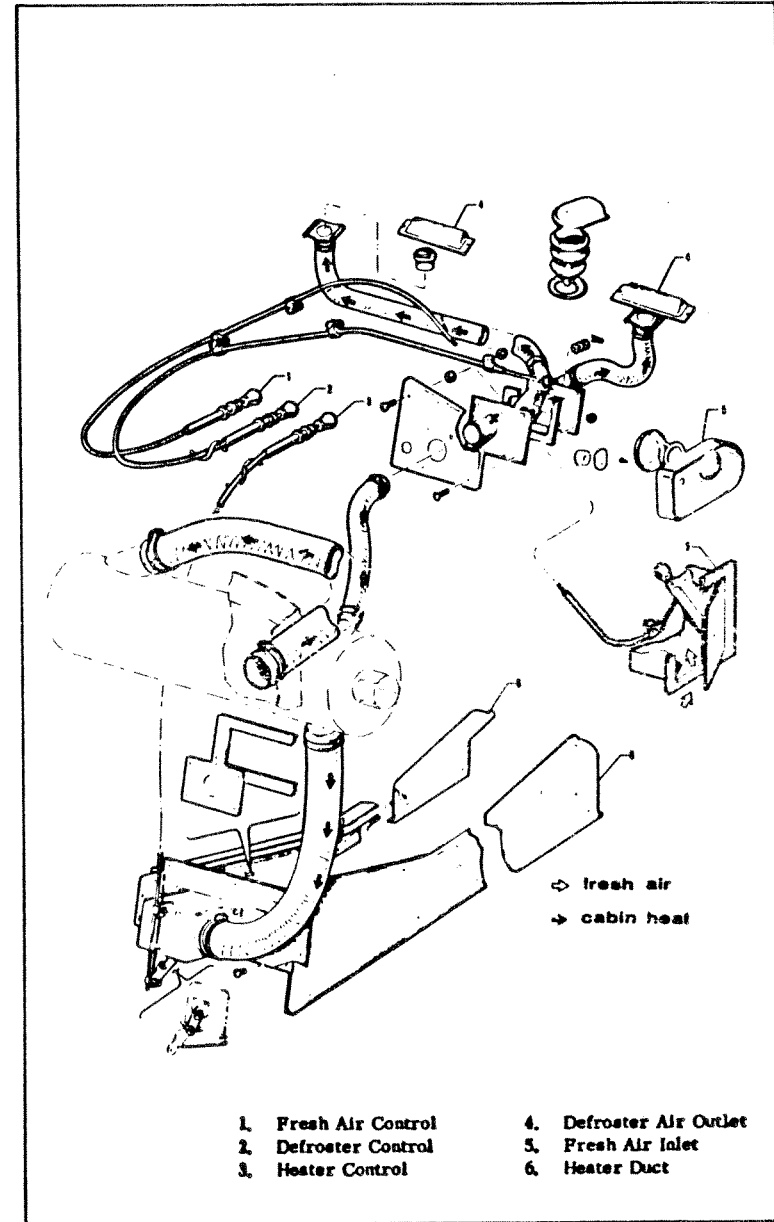

## CABIN FEATURES

The instrument panel of the Cherokee is designed to accommodate the customary advanced flight instruments and all the normally required power plant instruments. The Artificial Horizon, Directional Gyro and the Turn and Bank instruments are vacuum operated through use of a vacuum pump installed on the engine. A natural separation of the flight group and the power group is provided by placing the communications and radio navigational equipment in the center of the panel.

The front seats are adjustable fore and aft for pilot comfort and ease of entry and exit. A family seat installation is available which provides two additional seats. Each family seat is capable of carrying a full size adult which gives the Cherokee 140, 4-place capability.

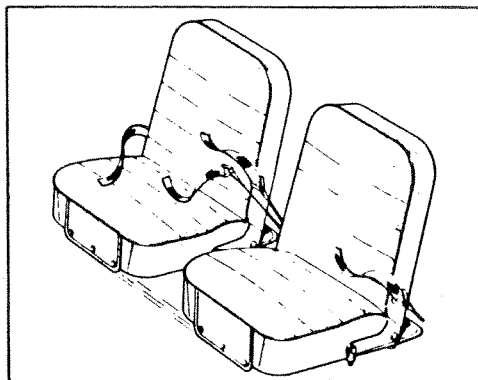

FAMILY SEATS

- |                               |                             |
|-------------------------------|-----------------------------|
| 1. Compass                    | 8. Vacuum Gauge             |
| 2. Airspeed Indicator         | 9. Instrument Cluster       |
| 3. Directional Gyro Indicator | 10. Turn and Bank Indicator |
| 4. Gyro Horizon Indicator     | 11. Clock                   |
| 5. Radio ADF                  | 12. Stall Warning Light     |
| 6. Radio VHF                  | 13. Altimeter               |
| 7. Tachometer                 | 14. Rate of Climb Indicator |

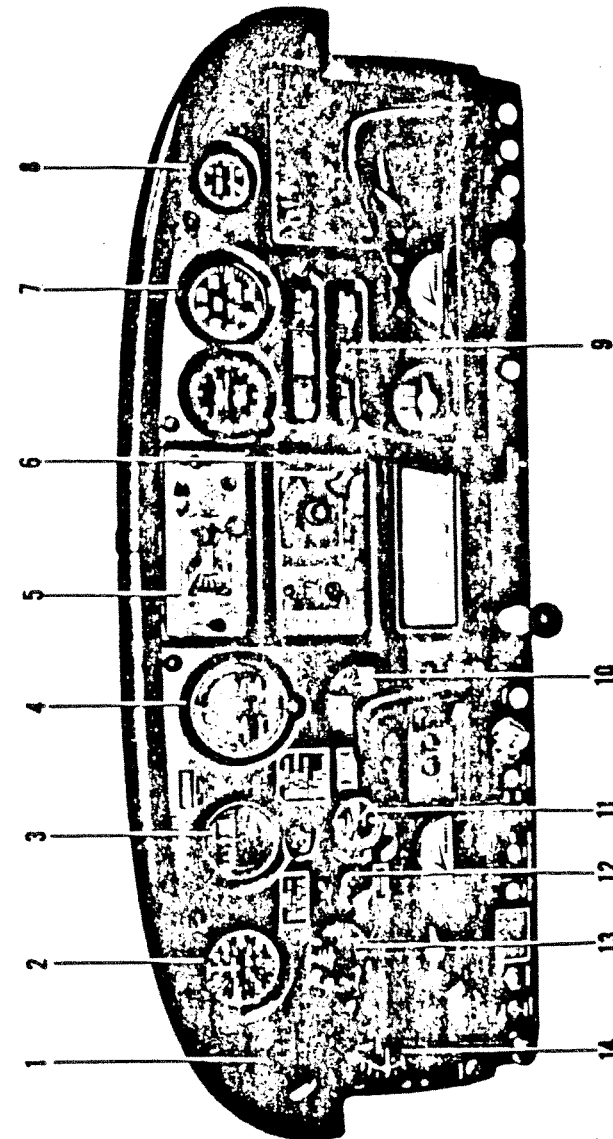

**SECTION III**  
**OPERATING INSTRUCTIONS**

Preflight . . . . .	13
Starting . . . . .	14
Warm-up . . . . .	15
Ground Check . . . . .	16
Take-off . . . . .	16
Climb . . . . .	17
Stalls . . . . .	18
Cruising . . . . .	18
Maneuvers . . . . .	19
Approach and Landing . . . . .	19
Mooring . . . . .	19a
Weight and Balance . . . . .	19a

## SECTION III

## OPERATING INSTRUCTIONS

## PREFLIGHT

The airplane should be given a thorough visual inspection prior to each flight. Particular attention should be given to the following items in the illustration below:

1. a. Master switch "ON."  
b. Check fuel quantity indicators (two tanks).  
c. Master switch and ignition "OFF."
2. a. Check for external damage, operational interference

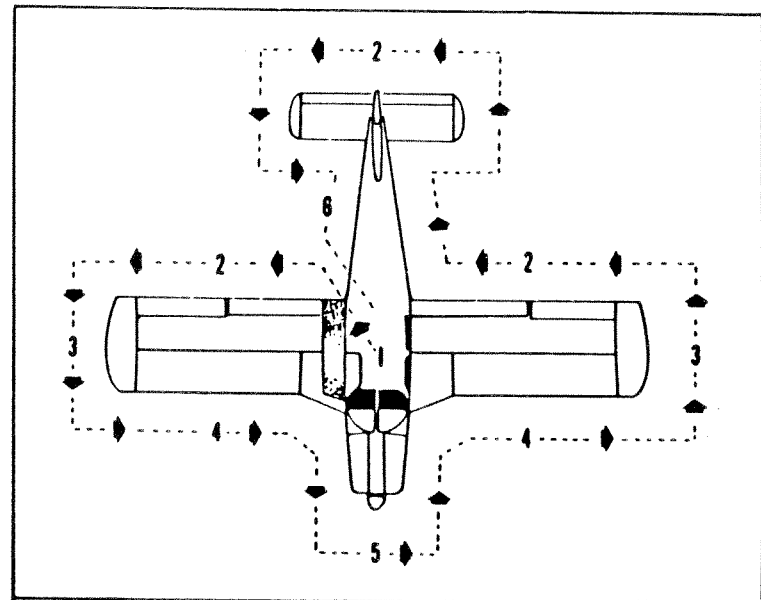

of control surfaces or hinges.

- b. Insure that wings and control surfaces are free of snow, ice or frost.
3. a. Visually check fuel supply, secure caps.
  - b. Drain fuel tank sumps.
  - c. Check that fuel system vents are open.
4. a. Check landing gear shock struts for proper inflation.
  - b. Check tires for cuts, wear and proper inflation.
  - c. Drain fuel system sump (left side of aircraft)
5. a. Inspect windshield for cleanliness.
  - b. Check the propeller and spinner for defects or nicks.
  - c. Check for obvious fuel or oil leaks.
  - d. Check oil level, 8 quarts maximum. (Insure dipstick is properly seated.)
    - e. Inspect cowling and inspection covers for security.
    - f. Check nose wheel tire for inflation, wear.
    - g. Check nose wheel shock strut for proper inflation.
6. a. Stow tow bar and control locks, if used.
  - b. Check baggage for proper storage and security.
  - c. Close and secure the baggage compartment door.
7. a. Upon entering aircraft ascertain that all primary flight controls operate properly.
  - b. Close and secure the cabin door.
  - c. Check that required papers are in order and in the aircraft.
  - d. Fasten seat belts and shoulder harness.

## STARTING ENGINE

After completion of the preflight inspection:

1. Lock the wheel brakes.
2. Set the carburetor heat control in the full "COLD" position.
3. Select the desired tank with the fuel valve.
4. Move the mixture to the full "RICH" position.
5. Open the throttle 1/8 to 1/4 inch.
6. Turn the electric fuel pump "ON."

In cold weather (below 40 degrees F.) prime the engine with one to three full strokes of the priming pump. If extremely cold, starting will be aided by pulling the propeller through by hand (switch "OFF") four to five revolutions. If the temperature is above 40 degrees the engine may be primed by three or four short quick strokes of the throttle.

After priming, turn the electric master switch on, engage the starter and allow the engine to turn approximately one full revolution, then turn the ignition switch to the "Left" magneto position.

When the engine is firing evenly, turn the magneto switch to the "Both" position and advance the throttle to 800 RPM. Check the oil pressure gauge for a pressure indication. If oil pressure is not indicated within thirty seconds, stop the engine and determine the trouble.

If the engine fails to start at the first attempt, another attempt should be made without priming. If this fails, it is possible that the engine is overprimed. Turn the magneto switch off, open the throttle slowly, and rotate the engine approximately ten revolutions with the starter. Reprime the engine with one half the amount used in the initial attempt, turn the magneto switch to "Left," and repeat the starting procedure. If the engine again fails to start, refer to the "Lycoming Operating Handbook, Section VII, Engine Troubles."

## WARM-UP

As soon as the engine starts, the oil pressure should be checked. If no pressure is indicated within thirty seconds, stop the engine and determine the trouble. In cold weather it will take a few seconds longer to get an oil pressure indication. Warm-up the engine at 800 to 1200 RPM.

Take-off may be made as soon as ground check is completed, providing that the throttle may be opened fully without back firing or skipping, and without reduction in engine oil pressure.



**GROUND CHECK**

Check the magnetos at 2000 RPM by switching from Both to Right then back to Both before switching to Left. Differential drop should not exceed 50 RPM while the total drop on either magneto should not exceed 175 RPM.

Check vacuum gauge, indicator should read 5" Hg  $\pm$  1" Hg at 2000 RPM.

Check both the oil temperature and pressure. The temperature may be low for some time if the engine is being run for the first time of the day, but as long as the pressure is within limits the engine is ready for take-off.

Carburetor heat should also be checked prior to take-off to be sure that the control is operating properly and to clear any ice which may have formed during taxiing. Avoid prolonged ground operation with carburetor heat ON as the air is unfiltered.

Mixture should be set full rich, except a minimum amount of leaning is permitted for smooth engine operation when taking off at high elevation.

**TAKE-OFF**

Just before take-off the following items should be checked:

- |                          |                            |
|--------------------------|----------------------------|
| 1. Controls free         | 7. Electric fuel pump "ON" |
| 2. Flaps "UP"            | 8. Engine gauges normal    |
| 3. Tab set               | 9. Door latched            |
| 4. Mixture "RICH"        | 10. Altimeter set          |
| 5. Carburetor heat "OFF" | 11. Fasten belts/harness   |
| 6. Fuel on proper tank   |                            |

The take-off technique is conventional for the Cherokee. The tab should be set slightly aft of neutral, with the exact setting determined by the loading of the aircraft. Allow the airplane to accelerate to 50 to 60 miles per hour, then ease back on the wheel enough to let the airplane fly itself off the ground. Premature raising of the nose, or raising it to an excessive angle, will result in a delayed take-off. After take-off let the aircraft accelerate to the desired climb speed by lowering the nose slightly.

**Short Field, Obstacle Clearance:**

Lower the flaps to 25° (second notch), accelerate to 55-60 miles per hour and ease back on the control wheel to rotate. After breaking ground, accelerate to the best angle of climb speed, 74 miles per hour. Slowly retract the flaps when the obstacle has been cleared and continue climb at 85 miles per hour.

**Short Field, No Obstacles:**

Lower the flaps to 25° (second notch) accelerate to 55-60 miles per hour. Ease back on the control wheel to rotate and accelerate to best rate of climb speed, 85 miles per hour. Slowly retract the flaps while climbing out.

**Soft Field, No Obstacle:**

Lower the flaps to 25° (second notch), accelerate aircraft and pull nose gear from the ground as soon as possible, lift off at lowest possible airspeed. Accelerate just above the ground to best rate of climb speed, 85 miles per hour. Climb out while slowly retracting the flaps.

**Soft Field, Obstacle Clearance:**

Lower flaps to 25° (second notch), accelerate aircraft, pull nose gear off as soon as possible and lift off at lowest possible airspeed. Accelerate just above the ground to best angle of climb speed, 74 miles per hour to climb past obstacle clearance height, continue climb while accelerating to best rate of climb speed, 85 miles per hour and slowly retract the flaps.

**CLIMB**

The best rate of climb at gross weight will be obtained at 85 miles per hour. The best angle of climb may be obtained at 74 miles per hour. At lighter than gross weight these speeds are reduced somewhat. For climbing enroute a speed of 100 miles per hour is recommended. This will produce better forward speed and increased visibility over the nose during the climb.

## STALLS

Stall characteristics of the Cherokee are conventional. Visual stall warning is provided by a red light located on the left side of the instrument panel which is turned on automatically between 5 and 10 miles per hour above stall speed. Gross weight stalling speed with power off and full flaps is 52 miles per hour at 1950 pounds and 54 miles per hour at 2150 pounds. With flaps up this speed is increased 9 miles per hour.

Intentional spins are prohibited in the normal category airplane. For approved maneuvers and entry speeds refer to the Flight Manual.

## CRUISING

The cruising speed of the Cherokee is determined by many factors including power setting, altitude, temperature, loading, and equipment installed on the airplane.

The normal cruising power is 75% of the rated horsepower of the engine. True airspeeds, which may be obtained at various altitudes and power settings, can be determined from the charts in "Section IV" of this handbook.

Use of the mixture control in cruising flight reduces fuel consumption significantly, especially at higher altitudes, and reduces lead deposits when the alternate fuels are used. The mixture should be leaned when 75% power or less is being used. If any doubt exists as to the amount of power being used, the mixture should be in the FULL RICH position for all operations. Always enrich the mixture before increasing power settings.

The continuous use of carburetor heat during cruising flight decreases engine efficiency. Unless icing conditions in the carburetor are severe, do not cruise with the heat on. Apply full carburetor heat slowly and only for a few seconds at intervals determined by icing severity.

In order to keep the airplane in best lateral trim during cruising flight, the fuel should be used alternately from each main tank. It is recommended that one main tank be used for one hour after take-off; the other main tank used until nearly exhausted, then return to the first main tank.

## MANEUVERS

The airplane is approved for certain aerobatic maneuvers up to a gross weight of 1950 lbs., provided it is loaded within the approved weight and center of gravity limits. (See Airplane Flight Manual) The maneuvers are spins, steep turns, lazy eights and chandelles.

## APPROACH AND LANDING

The airplane should be trimmed to an approach speed of about 85 miles per hour with flaps up. The flaps can be lowered at speeds up to 115 miles per hour, if desired, and if approach speed is reduced 3 miles per hour for each additional notch of flap. Carburetor heat should not be applied unless there is an indication of carburetor icing, since the use of carburetor heat causes a reduction in power which may be critical in case of a go-around. Full throttle operation with heat on is likely to cause detonation.

The amount of flap used during landings and the speed of the aircraft at contact with the runway should be varied according to the landing surface and existing conditions, both windwise and loadwise. It is generally good practice to contact the ground at the minimum possible safe speed consistent with existing conditions.

Normally, the best technique for short and slow landings is to use full flap and enough power to maintain the desired airspeed and approach flight path. Mixture should be full rich, fuel on the fullest tank, carburetor heat off, and electric fuel pump on. Reduce the speed during the flareout and contact the ground close to the stalling speed (55 to 65 MPH). After ground contact hold the nose wheel off as long as possible. As the airplane slows down, drop the nose and apply the brakes. There will be less chance of skidding the tires if the flaps are retracted before

applying the brakes. Braking is most effective when back pressure is applied to the control wheel, putting most of the aircraft weight on the main wheels. In high wind conditions, particularly in strong cross-winds, it may be desirable to approach the ground at higher than normal speeds with partial or no flaps.

To stop the engine after landing, pull the mixture control full back to idle cut-off. When alternate fuels are used, the engine should be run up to 1200 RPM for one minute prior to shutdown to clean out any unburned fuel. After the engine stops turn magneto and master switches off.

## MOORING

The Cherokee should be moved on the ground with the aid of the nose wheel tow bar provided with each plane and secured in the baggage compartment. Tie downs may be secured to rings provided under each wing, and to the tail skid. The aileron and stabilator controls should be secured by looping the safety belt through the control wheel and pulling it tight. The rudder is held in position by its connections to the nose wheel steering, and normally does not have to be secured. The flaps are locked when in the full up position, and should be left retracted.

## WEIGHT AND BALANCE

It is the responsibility of the owner and pilot to determine that the airplane remains within the allowable weight vs center of gravity envelope while in flight. For weight and balance data see the Airplane Flight Manual and Weight and Balance Form supplied with each airplane.

## SECTION IV

### PERFORMANCE CHARTS

Take-off Distance vs Density Altitude . . . . .	20
Rate of Climb vs Density Altitude . . . . .	21
True Airspeed vs Density Altitude (1950 lbs gross wt) . . . . .	22
True Airspeed vs Density Altitude (2150 lbs gross wt) . . . . .	23
Range vs Density Altitude (1950 lbs gross wt) . . . . .	23a
Range vs Density Altitude (2150 lbs gross wt) . . . . .	23b
Power vs Altitude (1950 lbs gross wt) . . . . .	24
Power vs Altitude (2150 lbs gross wt) . . . . .	25
Landing Distance vs Density Altitude . . . . .	25a
Glide Distance vs Altitude . . . . .	25b
Altitude Conversion Chart . . . . .	26

# PIPER CHEROKEE PA-28-140

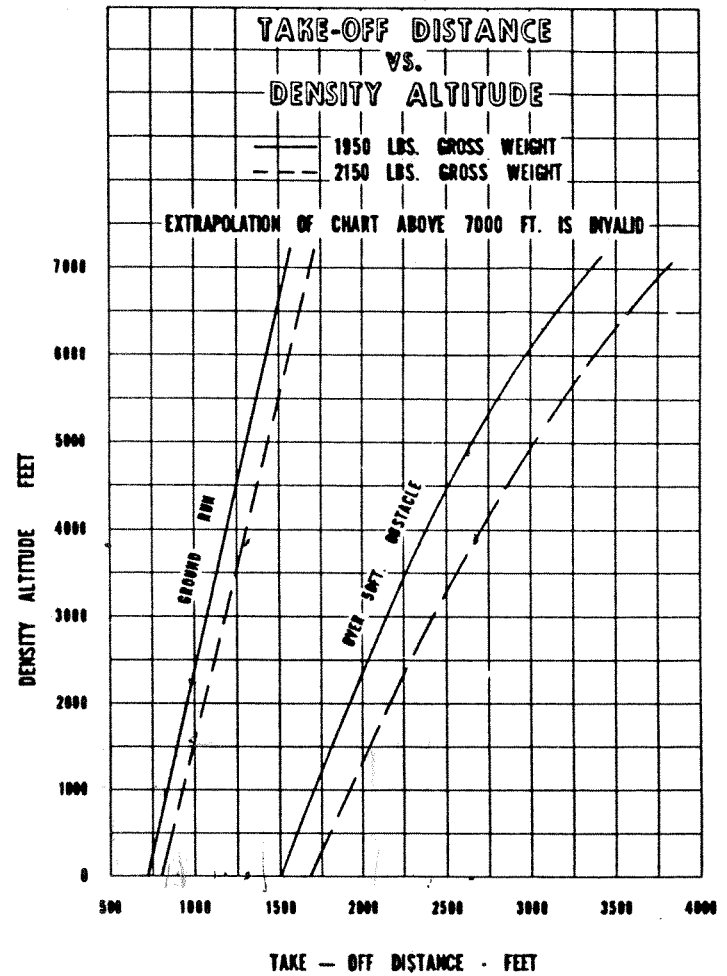

### PIPER CHEROKEE PA-28-140

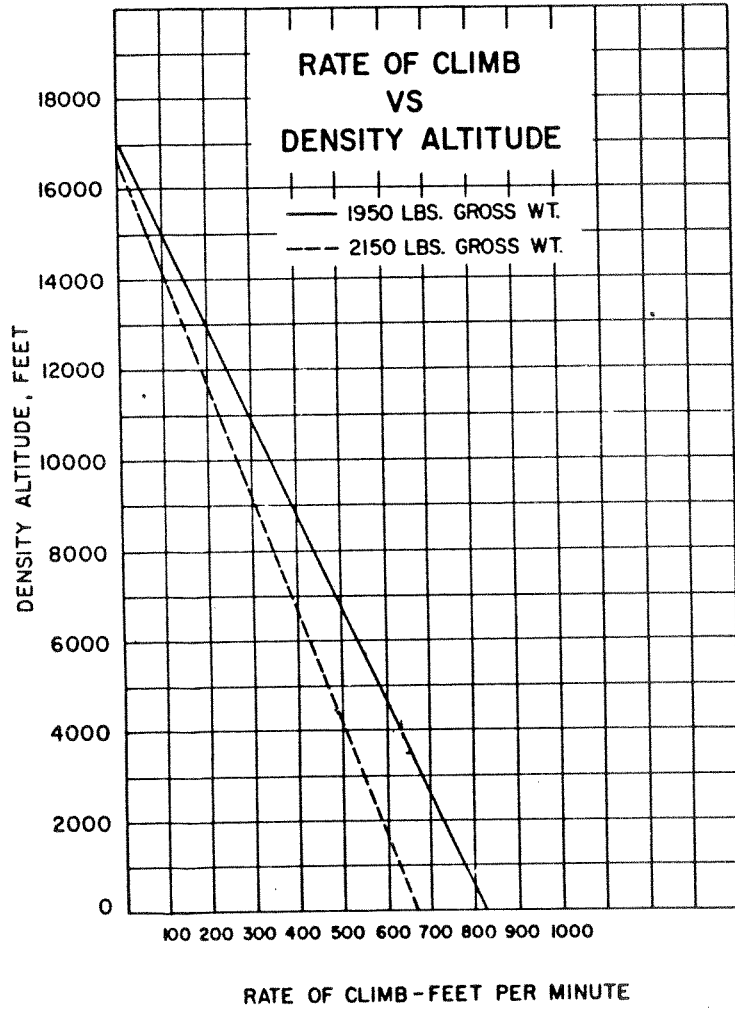

### PIPER CHEROKEE PA-28-140

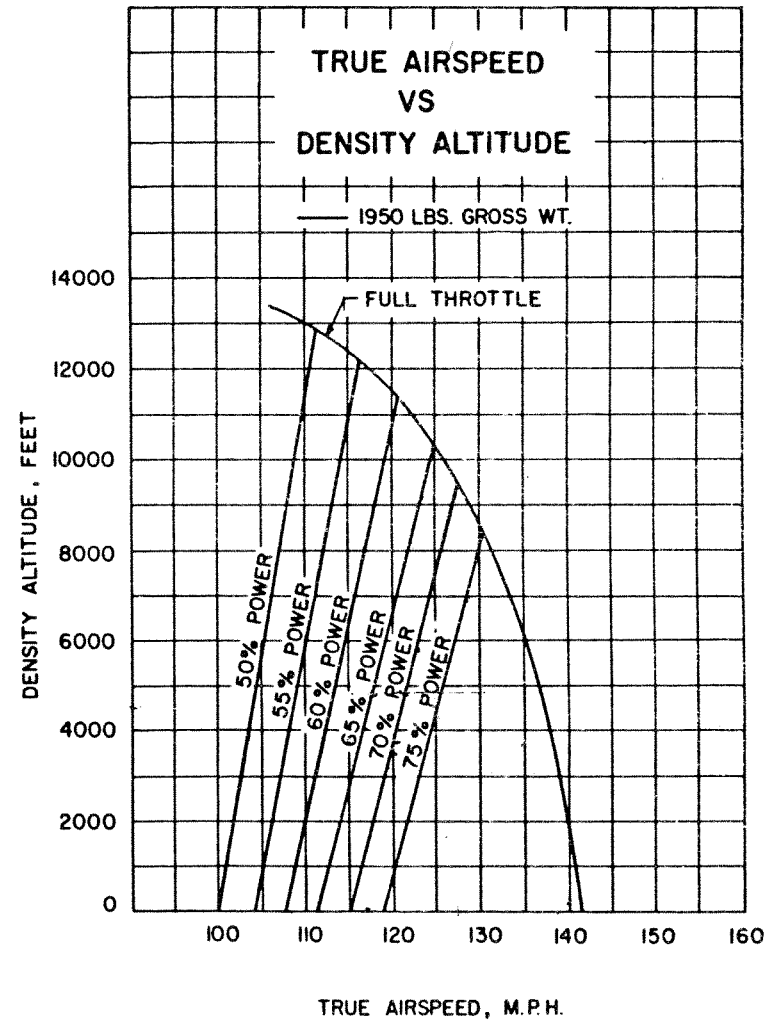

PIPER CHEROKEE  
PA-28-140

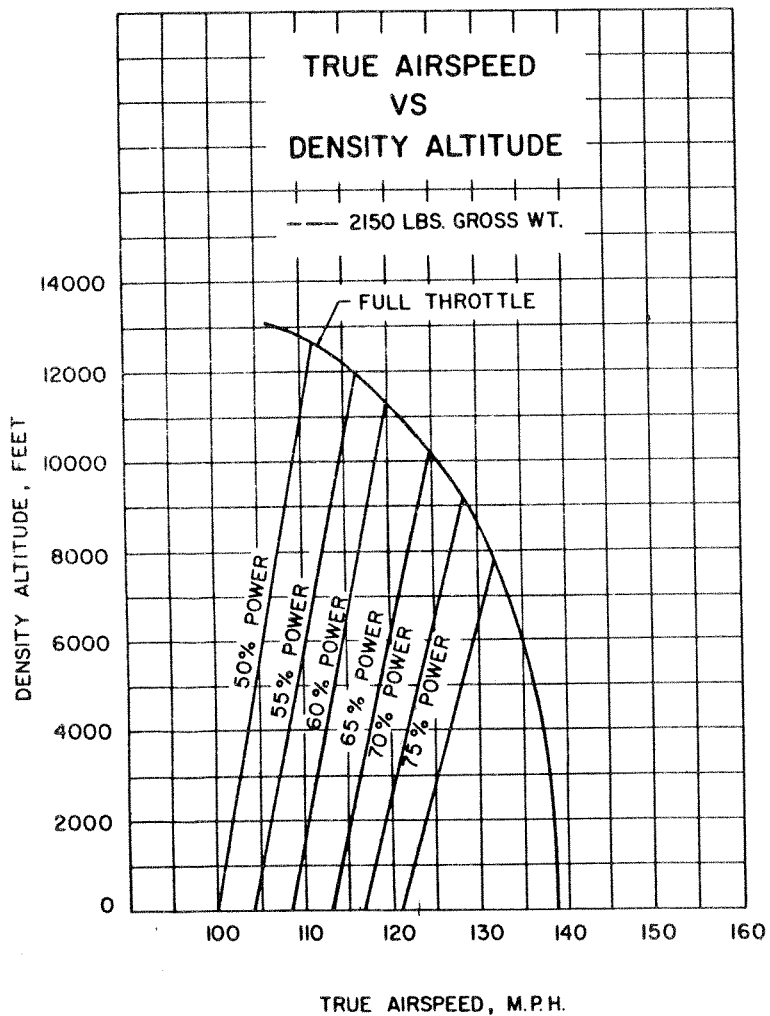

PIPER CHEROKEE  
PA-28-140

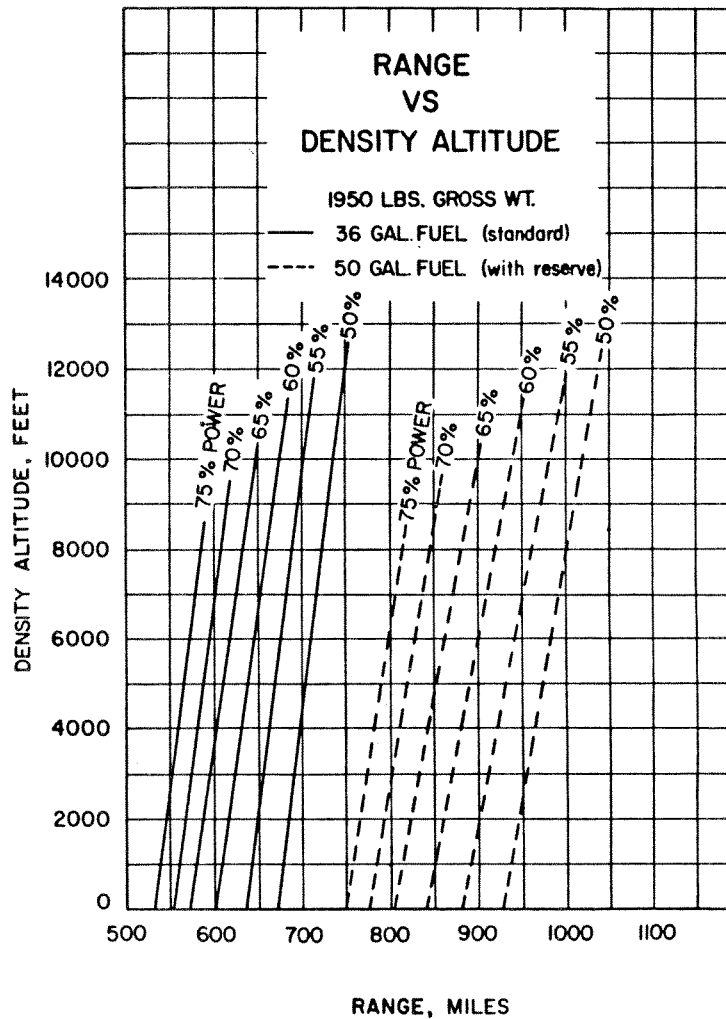

### PIPER CHEROKEE PA-28-140

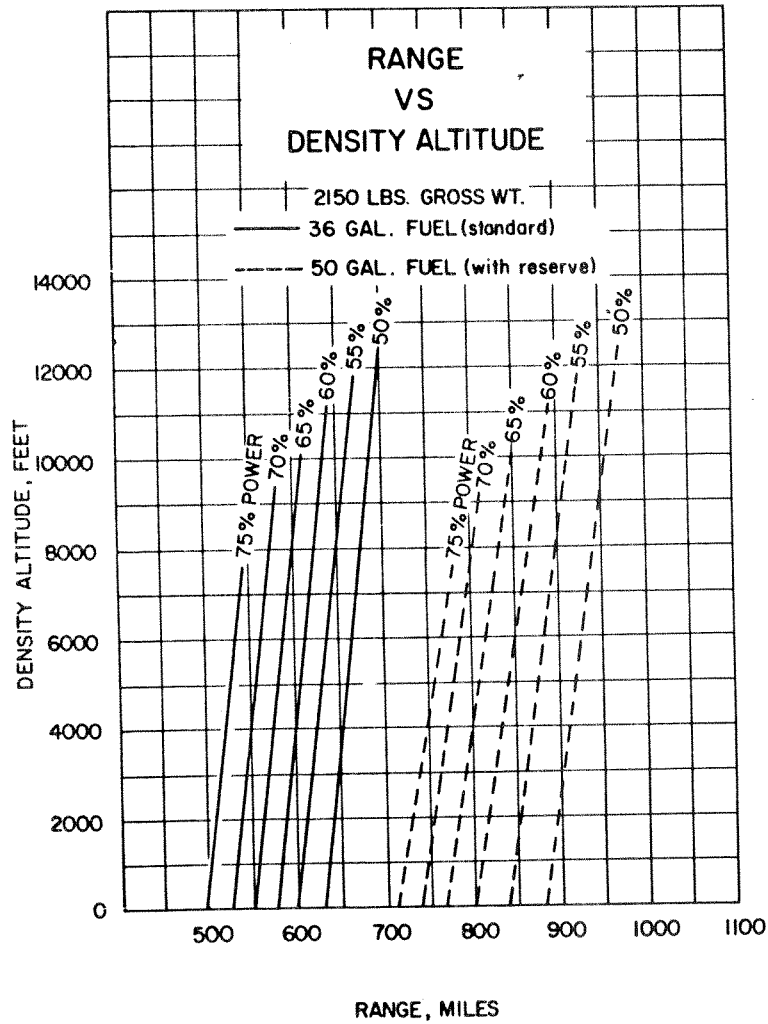

### PIPER CHEROKEE PA-28-140

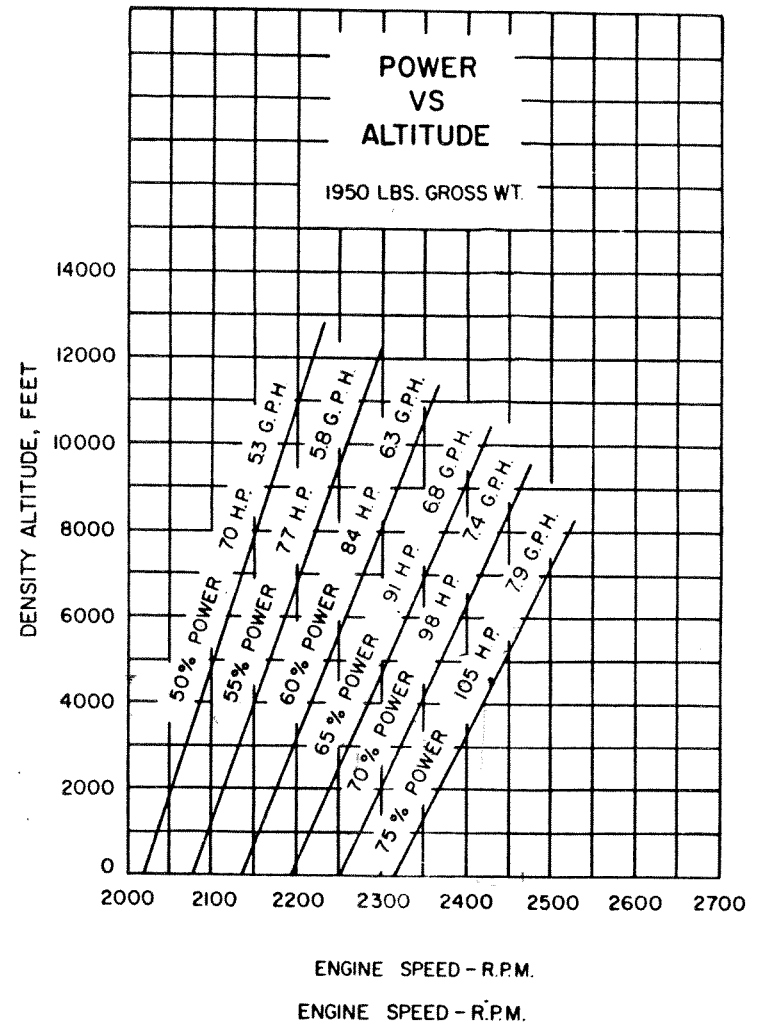

### PIPER CHEROKEE PA-28-140

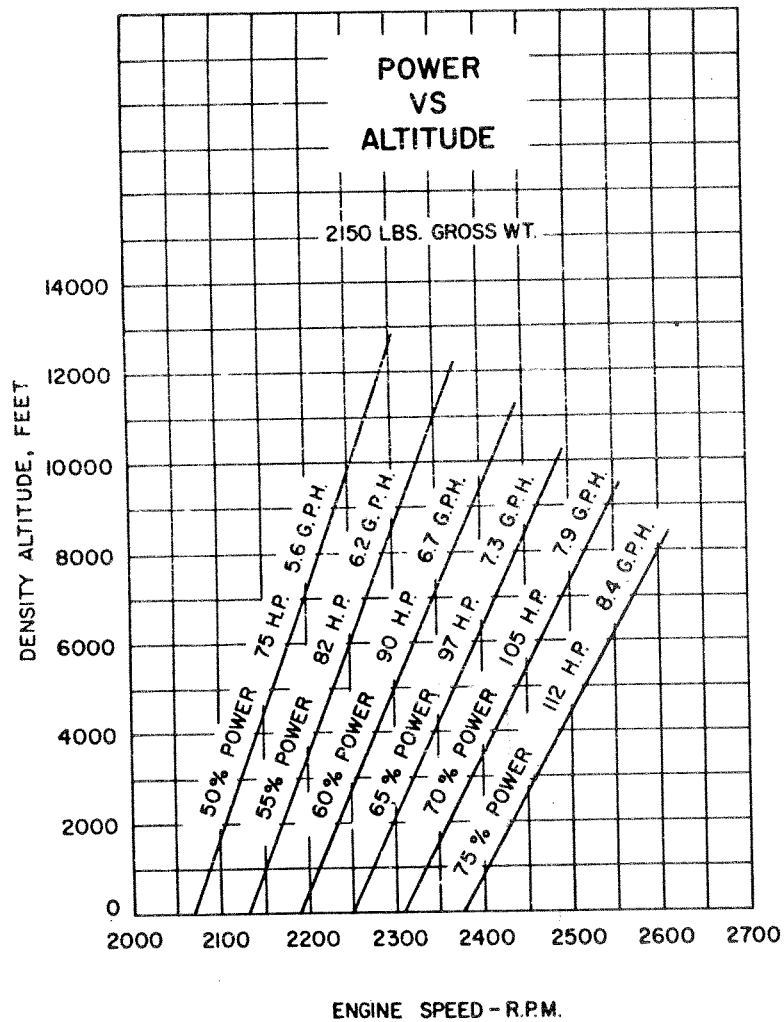

### PIPER CHEROKEE PA-28-140

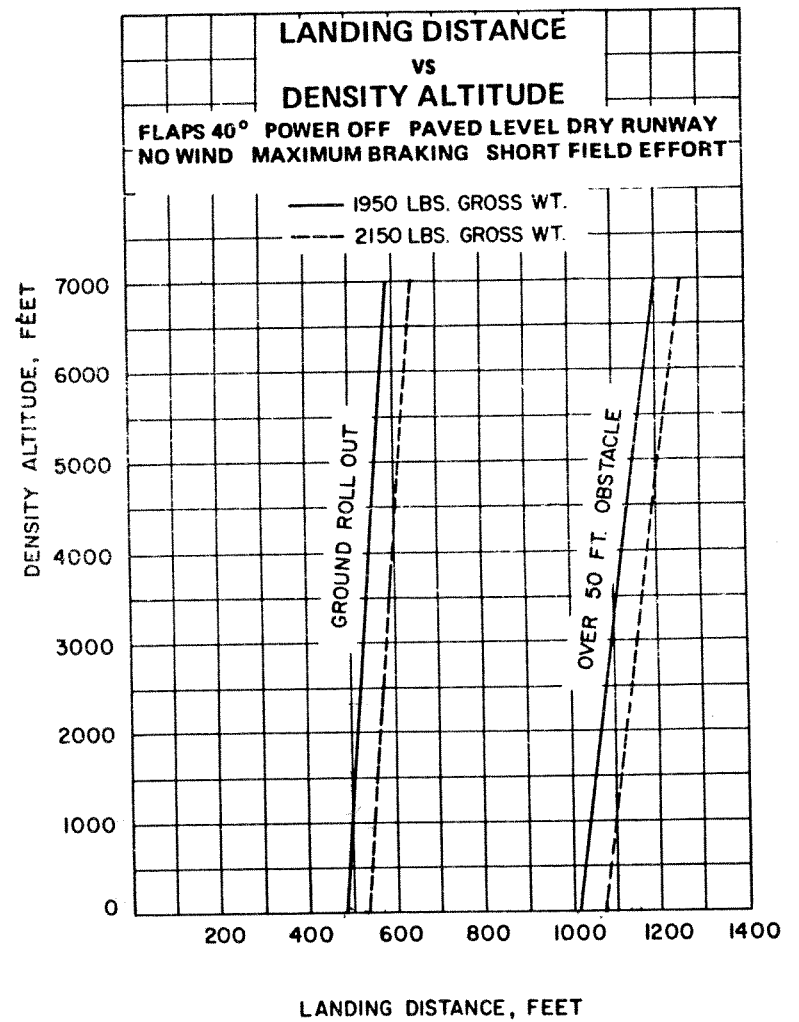



# PA-28-140 PIPER CHEROKEE

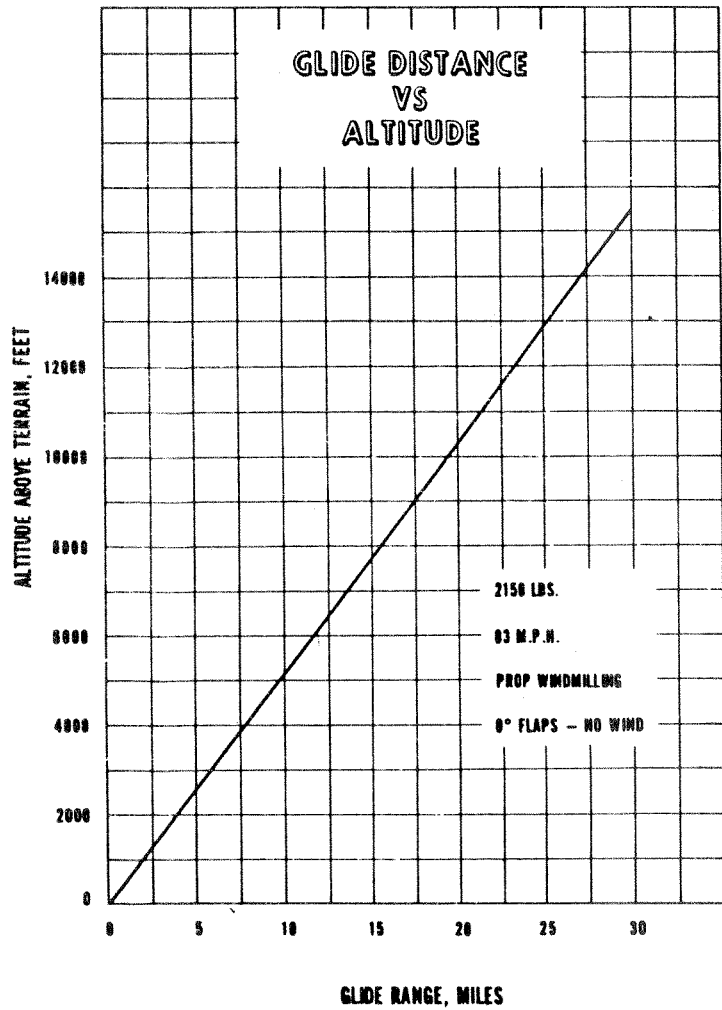

# PIPER CHEROKEE PA-28-140

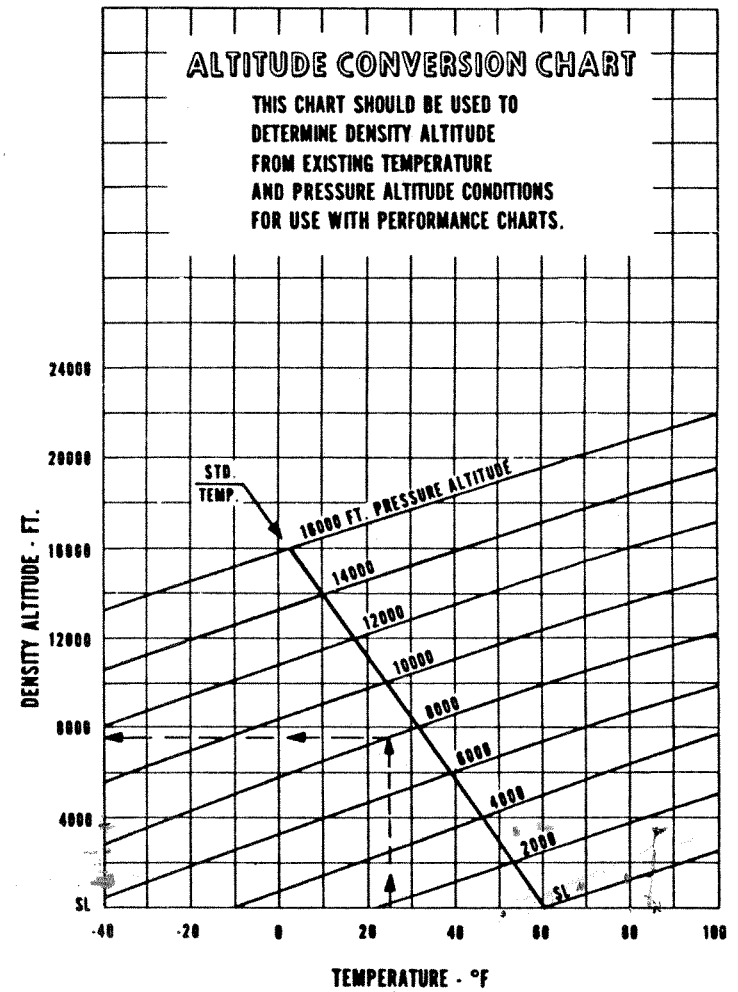

**SECTION V**  
**GENERAL MAINTENANCE**

Tire Inflation . . . . .	27
Battery Service . . . . .	27
Brake Service . . . . .	27
Landing Gear Service . . . . .	28
Fuel Requirements . . . . .	30
Oil Requirements . . . . .	31
Care of Air Filter . . . . .	32
Care of Windshield and Windows . . . . .	32
Serial Number Plate . . . . .	33
Leveling and Rigging . . . . .	33

## SECTION V

### GENERAL MAINTENANCE

#### TIRE INFLATION

For maximum service from the tires on the Cherokee, keep the tires inflated to the proper pressure of 24 pounds for the main gear and 24 pounds for the nose wheel. Interchange the tires on the main wheels, if necessary, to produce even wear. All wheels and tires are balanced before original installation, and the relationship of the tire, tube and wheel should be maintained, if at all possible. Out of balance wheels can cause extreme vibration on take-off. In the installation of new components, it may be necessary to rebalance the wheel with the tires mounted.

#### BATTERY SERVICE

The 12 volt battery is located in a stainless steel container under the baggage compartment floor. The container should be drained occasionally by opening the rubber cap on the drain tube. Check the battery for proper fluid level (below the baffle plates). Use a hydrometer to determine the density of the battery fluid.

If the battery is discharged, charge it before take-off as three volts are needed to excite the alternator. Recharge starting at a 4 amp rate and finishing with a 2 amp rate. Quick charges are not recommended.

#### BRAKE SERVICE

The brake system is filled with MIL-H-5606 (petroleum

base) hydraulic brake fluid. This should be checked at every 100 hour inspection and replenished when necessary by filling the brake reservoir on the firewall to the indicated level. If the system as a whole has to be refilled with fluid, this should be done by filling with the fluid under pressure from the brake end of the system. This will eliminate air from the system as it is being filled.

No adjustment of brake clearances is necessary on the Cherokee. If after extended service the brake blocks become worn excessively, they are easily replaced with new segments.

## LANDING GEAR SERVICE

Main wheels are easily removed by taking off the hub cap, axle nut, and the two bolts holding the brake segment in place, after which the wheel slips easily from the axle.

Tires are removed from the wheels by first deflating the tire, removing the three throughbolts, and separating the wheel halves.

Landing gear oleo struts should be checked for proper strut exposures and fluid leaks. The required extensions for the strut when under normal static load (empty weight of airplane plus full fuel and oil) is 3.25 inches for the nose gear and 4.50 inches for the main gear. Should the strut exposure be below that required, it should be determined whether air or oil is required by first raising the airplane on jacks. Depress the valve core to allow air to escape from the strut housing chamber. Remove the filler plug and slowly raise the strut to full compression. If the strut has sufficient fluid it will be visible up to the bottom of the filler plug hole and will then only require proper inflation.

Should fluid be below the bottom of the filler plug hole, oil should be added. Replace the plug with valve core removed, attach a clear plastic hose to the valve stem of the filler plug and submerge the other end in a container of hydraulic fluid (MIL-H-5606). Fully compress and extend the strut several

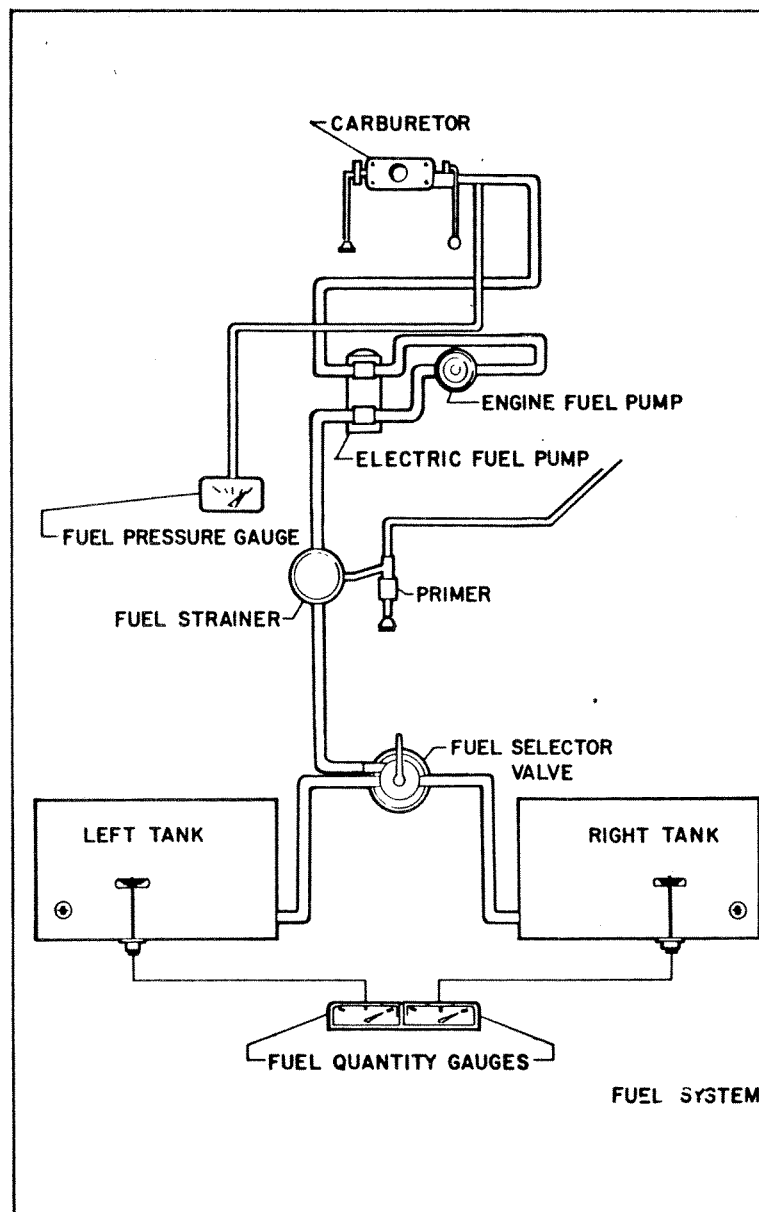

times thus drawing fluid from the container and expelling air from the strut chamber. To allow fluid to enter the bottom chamber of the main gear strut housing, the torque link assembly must be disconnected to let the strut be extended a minimum of 10 inches. (The nose gear torque links need not be disconnected.) Do not allow the strut to extend more than 12 inches. When air bubbles cease to flow through the hose, compress the strut fully and again check fluid level. Reinstall the valve core and filler plug, and the main gear torque links if disconnected. With fluid in the strut housing at the correct level, attach a strut pump to the air valve and with the airplane on the ground, inflate the oleo strut to the correct height.

In jacking the Cherokee for landing gear or other service, a jack kit (available through the Piper Aircraft Service Department) should be used. This kit consists of two hydraulic jacks and a tail stand. At least 350 pounds of ballast should be placed on the base of the tail stand before jacking up the airplane. The hydraulic jacks should be placed under the jack points on the bottom of the wing and the airplane jacked up until the tail skid is at the right height to attach the tail stand. After attaching the tail stand, and adding the ballast, the jacking may be continued until the airplane is at the height desired.

## FUEL REQUIREMENTS

The minimum aviation grade fuel for the PA-28-140 is 80/87. Since the use of lower grades can cause serious engine damage in a short period of time, the engine warranty is invalidated by the use of lower octanes.

Whenever 80/87 is not available, the lowest lead 100 grade should be used. (See Fuel Grade Comparison Chart, next page.) Refer to the latest issue of Lycoming Service Instruction No. 1070 for additional information.

The continuous use, more than 25% of the operating time, of the higher leaded fuels can result in increased engine deposits, both in the combustion chamber and in the engine oil. It may require increased

spark plug maintenance and more frequent oil changes. The frequency of spark plug maintenance and oil drain periods will be governed by the amount of lead per gallon and the type of operation. Operation at full rich mixture requires more frequent maintenance periods; therefore, it is important to use proper approved mixture leaning procedures.

Reference the latest issue of Lycoming Service Letter No. L185 for care, operation and maintenance of the airplane when using the higher leaded fuel.

A summary of the current grades as well as the previous fuel designations are shown in the following chart:

FUEL GRADE COMPARISON CHART

Previous Commercial Fuel Grades (ASTM-D910)			Current Commercial Fuel Grades (ASTM-D910-75)			Current Military Fuel Grades (MIL-G-5572E) Amendment No. 3		
Grade	Color	Max. TEL ml/U.S. gal.	Grade	Color	Max. TEL ml/U.S. gal.	Grade	Color	Max. TEL ml/U.S. gal.
80/87	red	0.5	80	red	0.5	80/87	red	0.5
91/98	blue	2.0	*100LL	blue	2.0	none	none	none
100/130	green	3.0	100	green	**3.0	100/130	green	**3.0
115/145	purple	4.6	none	none	none	115/145	purple	4.6

\* - Grade 100LL fuel in some over seas countries is currently colored green and designated as "100LL."

\*\* - Commercial fuel grade 100 and grade 100/130 (both of which are colored green) having TEL content of up to 4 ml/U.S. gallon are approved for use in all engines certificated for use with grade 100/130 fuel.

## OIL REQUIREMENTS

The capacity of the O-320 series engine is 8 quarts, and the minimum safe quantity is 2 quarts. It is recommended that the oil be changed every 50 hours and sooner under unfavorable operating conditions. Intervals between oil changes can be increased as much as 100% on engines equipped with full flow cartridge type oil filters, provided the element is replaced each 50 hours of operation and the specified octane fuel is used. Should fuel other than the specified octane rating for the power plant be used, refer to the latest issue of Lycoming Service Letter No. L185 and Lycoming Service Instruction No. 1014 for additional information and recommended service

procedures. The following grades are recommended for the specified temperatures:

Temperatures above 60° F	SAE 50
Temperatures between 30° F to 90° F	SAE 40
Temperatures between 0° F to 70° F	SAE 30
Temperatures below 10° F	SAE 20

Either mineral oil or anti-dispersant oil may be used, but the two types of oil may never be mixed.

### CARE OF AIR FILTER

The carburetor air filter must be cleaned at least once every fifty hours. Under extremely adverse conditions of operation it may be necessary to clean the filter daily. Extra filters are inexpensive and a spare should be kept on hand and used as a rapid replacement.

The filter manufacturer recommends that the filter be tapped gently to remove dirt particles. Do not blow out with compressed air.

### CARE OF WINDSHIELD AND WINDOWS

A certain amount of care is needed to keep the plexiglass windows clean and unmarred. The following procedure is recommended:

1. Flush with clean water and dislodge excess dirt, mud, etc., with your hand.
2. Wash with mild soap and water. Use a soft cloth or sponge, do not rub.

3. Remove oil, grease or sealing compounds with a soft cloth and kerosene.

4. After cleaning, apply a thin coat of hard polishing wax. Rub lightly with a soft cloth.

5. A severe scratch or mar may be removed by using jeweler's rouge to rub out the scratch, smoothing, and then applying wax.

### SERIAL NUMBER PLATE

The serial number plate is located near the stabilator on the left side of the airplane. Refer to this number for service or warranty matters.

### LEVELING AND RIGGING

Leveling the Cherokee for purposes of weighing or rigging is accomplished as follows:

1. Partially withdraw two machine screws located immediately below the left front side window. These screws are leveling points and the airplane is longitudinally level when a level placed on the heads of these screws indicates level.

2. To put the airplane in a longitudinally level position on scales, first block the main gear oleos in the fully extended position, then deflate the nose wheel tire until the proper attitude is obtained. For rigging only, the airplane may be placed on jacks for leveling.

3. To level the airplane laterally, place a level across the baggage compartment floor along the rear bulkhead.

Rigging: Although the fixed flight surfaces on the Cherokee cannot be adjusted for rigging purposes, it may be necessary upon occasion to check the position of these surfaces. The movable surfaces all have adjustable stops, as well as adjustable turnbuckles on the cables or push-pull tubes, so that their range

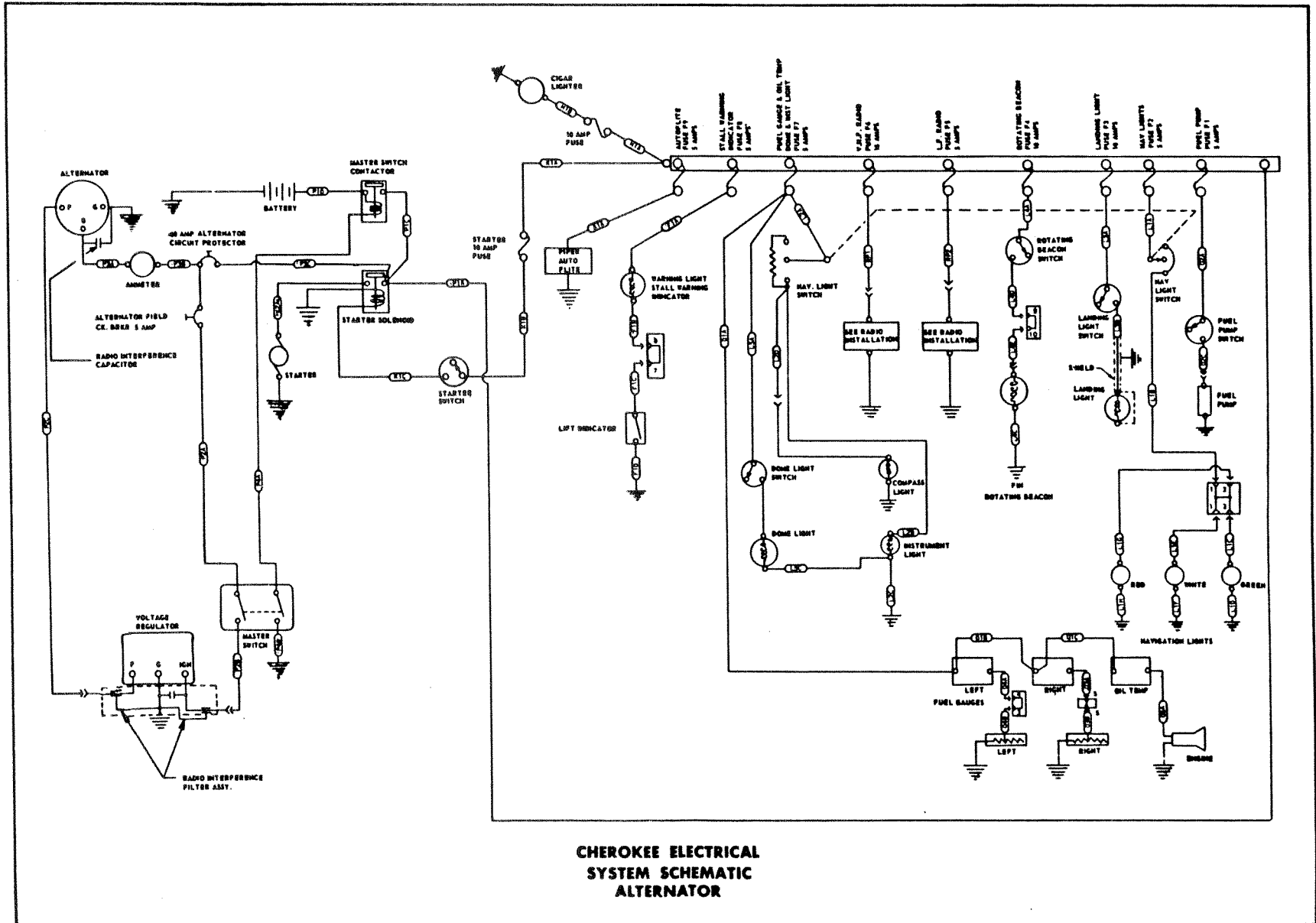

of travel can be altered. The positions and angular travels of the various surfaces are as follows:

1. Wings: 7° dihedral, 2° washout.
2. Stabilator Travel: 18° up, 2° down, tolerance  $\pm 1^\circ$ .
3. Fin should be vertical and in line with center of fuselage.
4. Aileron Travel: 30° up, 15° down, tolerance  $\pm 2^\circ$ .
5. Flap Travel: 10°, 25°, 40°, tolerance  $\pm 2^\circ$ .
6. Rudder Travel: 27° right and left, tolerance  $\pm 2^\circ$ .
7. Stabilator Tab Travel: 3° up, 12° down, tolerance  $\pm 1^\circ$ .

Cable tensions for the various controls are as follows:

Rudder: 40  $\pm$  5 lbs.      Stabilator: 40  $\pm$  5 lbs.

Ailerons: 40  $\pm$  5 lbs.      Stabilator Trim: 5  $\pm$  1 lb.



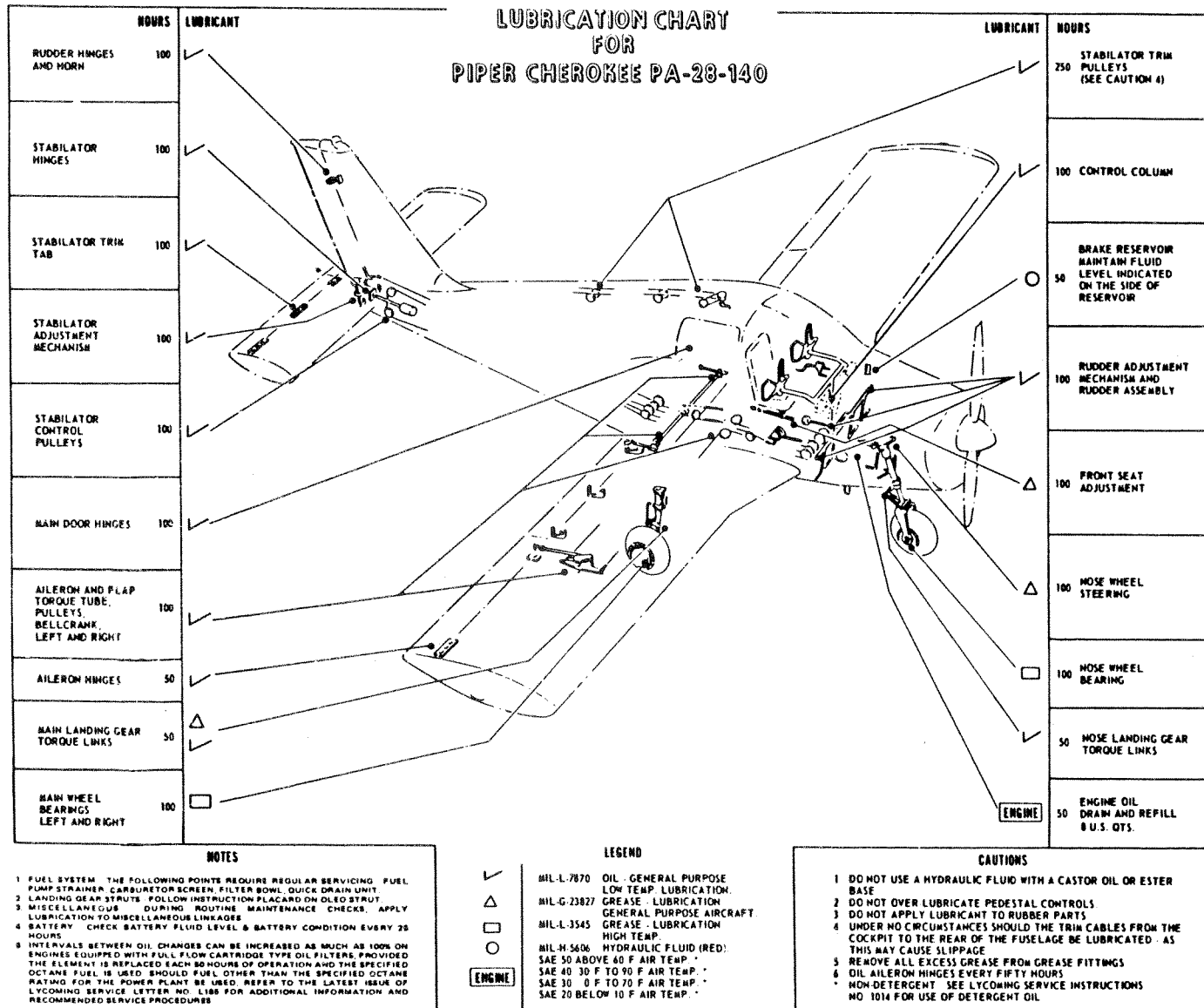

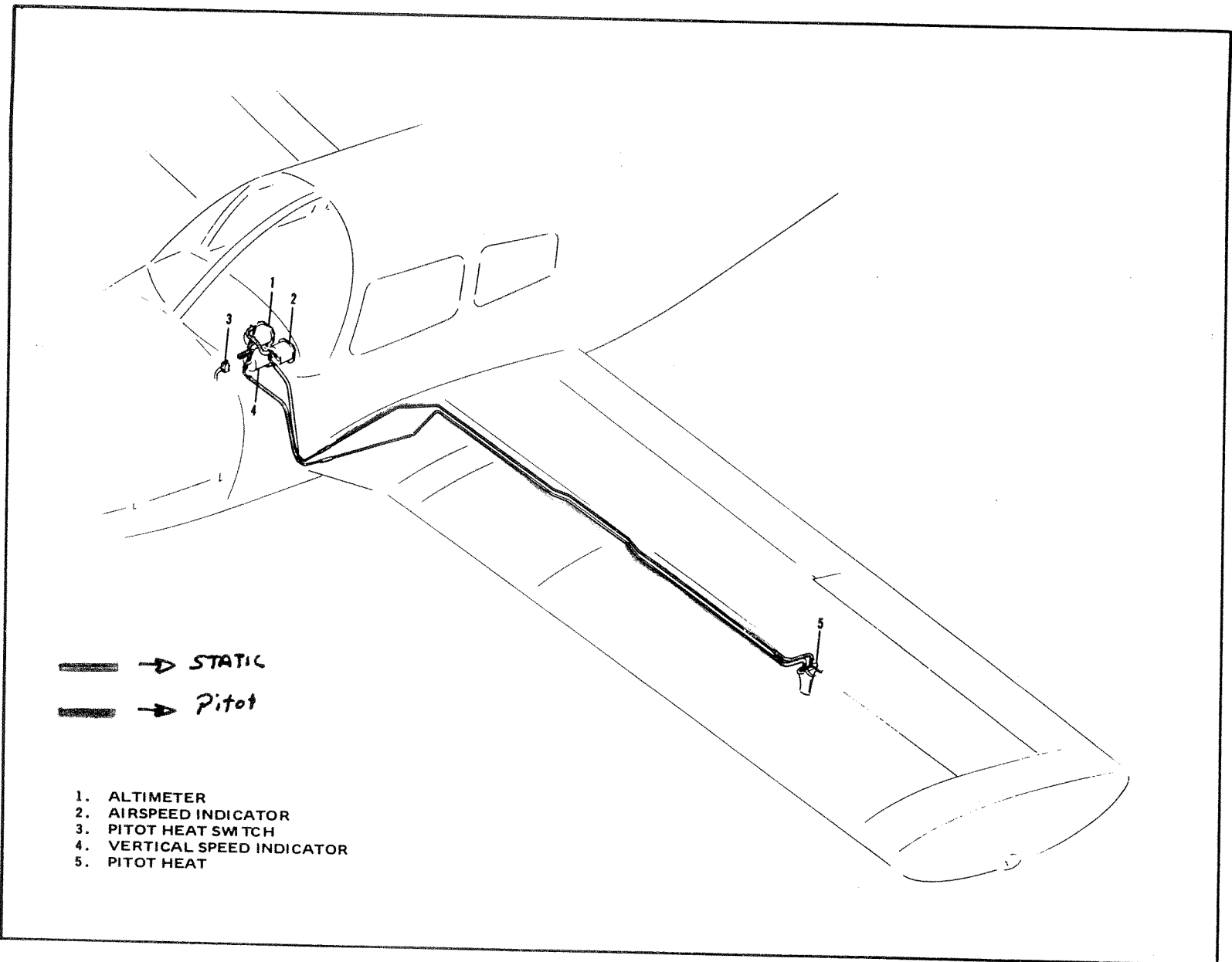

Pitot-Static System